



# Close Edge Studs

## Series CHE & CHES



CHE studs allow installation closer to material edge than standard studs without distortion of sheet edge. Provides flush-head assembly in material thickness of .040 in. (1 mm) or more.

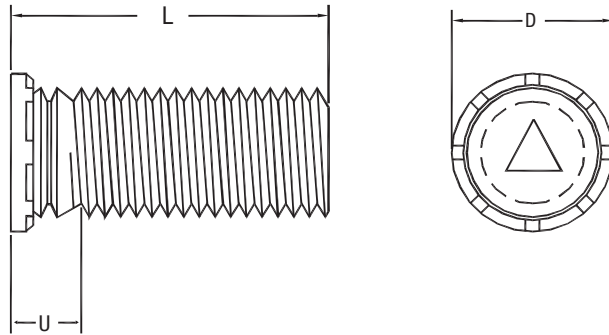

Series	Material	Finish
CHE	Heat-treated Carbon Steel	Zinc* Clear
CHES	300 Series Stainless Steel	Passivated ASTM A380

\*See Finish Spec. on Page 6.

Thread: External 2A, ANSI B1.1 (6g ANSI/ASME B1.13M).\*\*

Use in: CHE – Materials with HRB-80 or less.  
CHES – Materials with HRB-70 or less.

Part Number Structure:

CHE 256 -4



\*\*See Note 3 on Page 6 for Gauging Spec.

### Dimensions & Specifications

Note: Min Sheet Thickness .040 in.

INCH (in.)	Thread Size	Series		Thread Code	L Length $\pm .015$ in.										+0.003 -0.000	D $\pm .015$	U Max.	Min.
		Steel	SS		.250	.312	.375	.500	.625	.750	.875	1.00	1.25	1.50				
#2-56	CHE	CHES	256	-4	-5	-6	-8	-10	-12					.085	.112	.080	.098	
#4-40	CHE	CHES	440	-4	-5	-6	-8	-10	-12	-14	-16			.111	.138	.085	.124	
#6-32	CHE	CHES	632	-4	-5	-6	-8	-10	-12	-14	-16	-20	-24	.137	.164	.090	.150	
#8-32	CHE	CHES	832	-4	-5	-6	-8	-10	-12	-14	-16	-20	-24	.163	.190	.090	.176	
#10-32	CHE	CHES	1032		-5	-6	-8	-10	-12	-14	-16	-20	-24	.189	.225	.100	.210	

### Dimensions & Specifications

Note: Min Sheet Thickness 1 mm.

METRIC (mm)	Thread Size	Series		Thread Code	L Length $\pm .4$ mm										+0.08 -0.00	D $\pm .4$	U Max.	Min.
		Steel	SS		6	8	10	12	15	18	20	25	30	35				
M2.5 x 0.45	CHE	CHES	M2.5	-6	-8	-10	-12	-15	-18					2.5	3.15	2.1	2.8	
M3 x 0.5	CHE	CHES	M3	-6	-8	-10	-12	-15	-18	-20	-25			3	3.65	2.1	3.3	
M3.5 x 0.6	CHE	CHES	M3.5	-6	-8	-10	-12	-15	-18	-20	-25	-30		3.5	4.15	2.3	3.8	
M4 x 0.7	CHE	CHES	M4	-6	-8	-10	-12	-15	-18	-20	-25	-30	-35	4	4.65	2.4	4.3	
M5 x 0.8	CHE	CHES	M5		-8	-10	-12	-15	-18	-20	-25	-30	-35	5	5.9	2.7	5.6	



# Close Edge Studs

## Series CHE & CHES



Continued from previous page.

### Installation Procedure

- 1) Prepare the correct size hole in the base material by punching or drilling. Do not deburr hole.
- 2) Place the stud through the hole in the base material and insert into the support anvil.
- 3) Apply sufficient squeezing force with a shop press until the head of the fastener is flush with the sheet material.

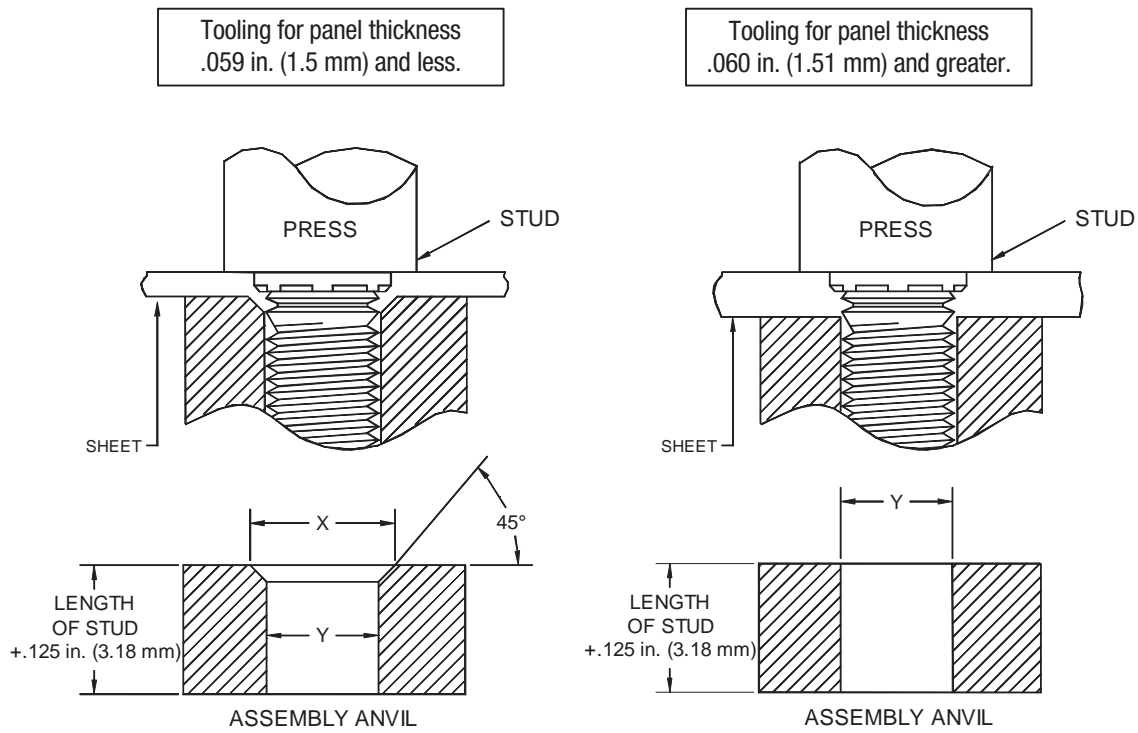

INCH (in.)	SERIES	Anvil Dimensions (in)	
		X +.004	Y + .003
	256	.110	.087
	440	.136	.113
	632	.162	.139
	832	.188	.165
	1032	.216	.191

METRIC (mm)	SERIES	Anvil Dimensions (mm)	
		X +.01	Y + .08
	M2.5	3.1	2.53
	M3	3.6	3.03
	M3.5	4.1	3.53
	M4	4.6	4.03
	M5	5.6	5.03





# Close Edge Studs





## Series CHE & CHES

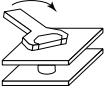
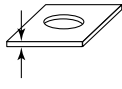

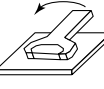
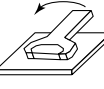
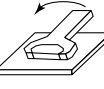
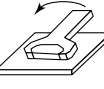
Continued from previous page.

### Installation & Performance Data

INCH (in.)									
	Thread Code	Max. Nut Tightening Torque (in. lbs.)	Sheet Thickness And Material	Sheet Hardness HRB	Installation Force (lbs.)	Pushout (lbs.)	Torque Out (in.-lbs.)	Pull Thru (lbs.)	Test Bushing Hole Size
256		2.3	.047 Aluminum	33	700	55	4	230	.106
		2.3	.045 Cold Rolled Steel	54	1200	85	8	425	.106
440		4.0	.047 Aluminum	33	1000	60	5	300	.132
		5.0	.045 Cold Rolled Steel	54	1200	105	11	580	.132
632		5.4	.047 Aluminum	33	1000	65	6.5	325	.158
		9.0	.045 Cold Rolled Steel	54	1500	110	15	650	.158
832		6.9	.047 Aluminum	33	1200	80	9	350	.184
		15.2	.045 Cold Rolled Steel	54	1500	125	18	740	.184
1032		9.7	.047 Aluminum	33	2500	115	18	395	.210
		19.4	.045 Cold Rolled Steel	54	4500	210	38	800	.210

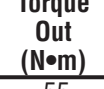
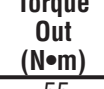
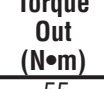
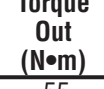
METRIC (mm)									
	Thread Code	Max. Nut Tightening Torque (N.m.)	Sheet Thickness And Material	Sheet Hardness HRB	Installation Force (kN)	Pushout (N)	Torque Out (N•m)	Pull Thru (N)	Test Bushing Hole Size
M2.5		.41	1.2mm Aluminum	33	3.1	285	.55	1200	3
		.41	1.1mm Cold Rolled Steel	54	5.3	450	1.1	2250	3
M3		.46	1.2mm Aluminum	33	4.4	285	.65	1300	3.5
		.74	1.1mm Cold Rolled Steel	54	5.3	475	1.25	2500	3.5
M3.5		.58	1.2mm Aluminum	33	4.4	290	.76	1400	4
		1.15	1.1mm Cold Rolled Steel	54	6.6	500	1.75	2800	4
M4		.75	1.2mm Aluminum	33	5.3	365	1.1	1550	4.5
		1.7	1.1mm Cold Rolled Steel	54	6.6	550	2.1	3300	4.5
M5		1.11	1.2mm Aluminum	33	11.1	530	2.2	1850	5.5
		2.25	1.1mm Cold Rolled Steel	54	20	1000	4.4	3750	5.5